

***Trinitron® Color TV***

---

**Operating Instructions**

**KV-13M20  
KV-13M30  
KV-13M31**

**KV-14PM1  
KV-14R20  
KV-14R20C  
KV-14RD1**

**KV-20M20  
KV-20S20  
KV-20S21  
KV-20S30  
KV-20V60**

**KV-21PM1  
KV-21PS1  
KV-21R20  
KV-21R20C  
KV-21RD1  
KV-21RS20  
KV-21RS20C  
KV-21RS30C  
KV-21SD1**

# Warnings and Cautions

To prevent fire or shock hazard, do not expose the TV to rain or moisture.

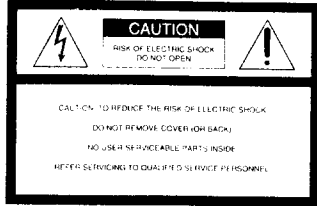

 This symbol is intended to alert the user to the presence of uninsulated "dangerous voltage" within the product's enclosure that may be of sufficient magnitude to constitute a risk of electric shock to persons.

 This symbol is intended to alert the user to the presence of important operating and maintenance (servicing) instructions in the literature accompanying the appliance.

### CAUTION

When using TV games, computers, and similar products with your TV, keep the brightness and contrast functions at low settings. If a fixed (non-moving) pattern is left on the screen for long periods of time at a high brightness or contrast setting, the image can be permanently imprinted onto the screen. These types of imprints are not covered by your warranty because they are the result of misuse.

You are cautioned that any changes or modifications not expressly approved in this manual could void your authority to operate this equipment.

### Safety Precautions

- Operate the TV only on 120 V AC (Except KV-14R20C, 21R20C, 21RS20C, 21RS30C).
- Operate the TV only on 220 V AC (KV-14R20C, 21R20C, 21RS20C, 21RS30C only).
- One blade of the power plug is wider than the other for safety purposes and will fit into the power outlet only one way. If you are unable to insert the plug fully into the outlet, contact your dealer. TO PREVENT ELECTRIC SHOCK, DO NOT USE THIS POLARIZED AC PLUG UNLESS THE BLADES CAN BE FULLY INSERTED TO PREVENT BLADE EXPOSURE.

- If any liquid or solid object falls into the TV, unplug it and have it checked by qualified personnel before operating it further.
- Unplug the TV from the wall outlet if you are not going to use it for several days or more. To disconnect the cord, pull it out by the plug. Never pull the cord itself.

For more safety information, see the IMPORTANT SAFEGUARDS leaflet packed with your TV.

### Protecting the TV

- To prevent internal heat build-up, do not block the ventilation openings.
- Do not install the TV in a hot or humid place, or in a place subject to excessive dust or mechanical vibration.

### Note on Caption Vision

This television receiver provides display of television closed captioning in accordance with § 15.119 of the FCC rules.

### Note to CATV System Installer

Article 820-40 of the NEC that provides guidelines for proper grounding and, in particular, specifies that the cable ground shall be connected to the grounding system of the building, as close to the point of cable entry as practical.

Use of this television for other than private viewing of programs broadcast on UHF or VHF or transmitted by cable companies for the use of the general public may require authorization from the broadcaster/cable company and/or program owner.

### Owner's Record

Record the model and serial numbers located on the rear of the TV in the spaces below. Refer to them if you call your Sony dealer regarding this product.

Model Number:

Serial Number:

# Step 1: Connecting the TV

You can use an indoor antenna, outdoor antenna, or cable system with your TV. Outdoor antennas or cable TV systems usually provide the best picture quality.

## Connecting an Indoor, Outdoor or Cable Antenna

Connect your antenna or cable to the TV's VHF/UHF antenna terminal.

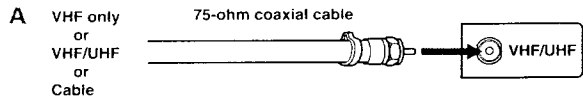

If you cannot connect your antenna or cable directly to the TV antenna terminal, follow one of the diagrams below.

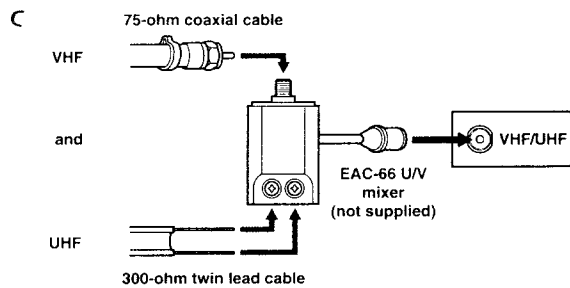
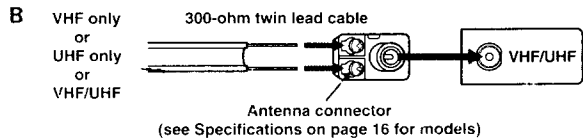

## Connecting to a Cable TV System Through a Cable Box

If your cable system requires use of a cable box, make the connection as shown below.

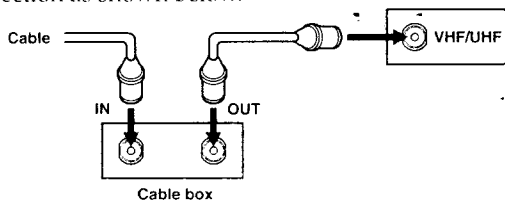

## Connecting a VCR

See your VCR instructions to set up the VCR. After connecting the VCR to the TV, you will be able to do the following:

- Watch video tapes
- Record one TV program while viewing another

Check the model number of your TV and select the appropriate connection diagram.

### Notes

- If your cable system requires use of a Cable Box, install it between the antenna cable and the VCR.
- For a monaural VCR, connect the audio output of the VCR to AUDIO L (MONO) on the TV.
- Connect your S-Video cable (KV-20V60 only) to the S-VIDEO input on the TV. S-Video will override your standard video input, providing the most stable picture. S-Video does not provide audio output.

Warnings and Cautions • Connecting the TV • Connecting an Antenna • Connecting a Cable Box • Connecting a VCR

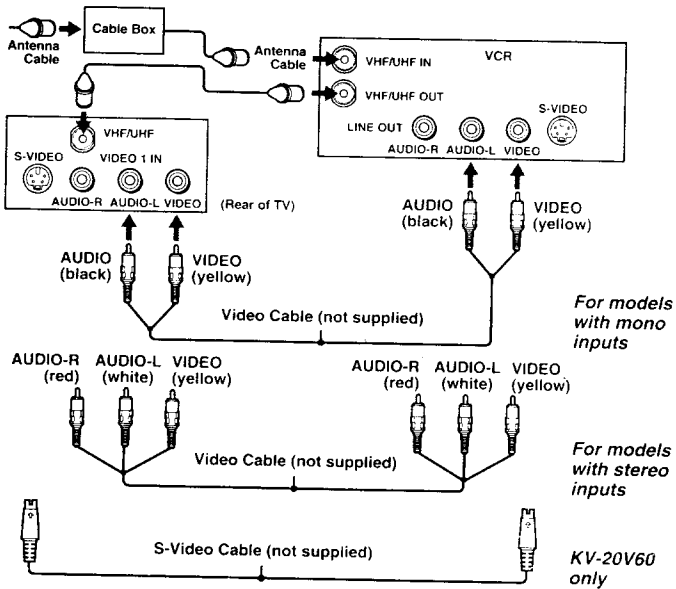

## Connecting a Camcorder

**KV-13M30, 13M31, 20S30, 20V60, 21RS30C only**

Use this connection to view a video tape from a camcorder.

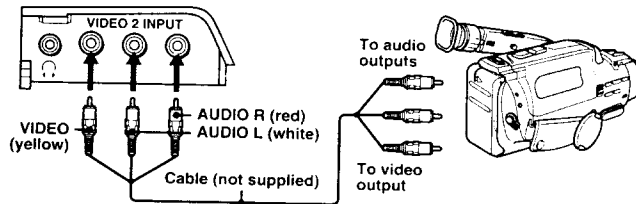

### Notes

- For a monaural camcorder, connect the audio output of the camcorder to AUDIO L (MONO) on the TV.
- If you are connecting your camcorder to a monaural TV (KV-13M30, 13M31 only), plug the audio connector into the AUDIO input on the TV.
- You can also connect a camcorder to inputs on the rear of the TV (all models).

## Connecting an Audio System

**KV-20S30, 20V60, 21RS30C only**

To listen to TV audio through a separate stereo system, connect the TV as shown below. See page 11 to switch to the external speakers.

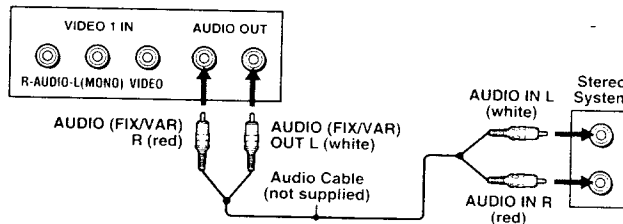

## Step 2: Using the Remote Control

Instructions in this manual are based on using the remote control. You can also use the controls on the TV.

The menu illustrations are from KV-20M20. When features found on other models are discussed, the manual lists the models covered by that specific set of menus.

### Note

- The menu disappears 90 seconds after you press a button, or immediately after you press MENU.
- Refer to separate instructions for remote control pre-programming (KV-20V60 only).

## Inserting Batteries

Insert two size AA (R6) batteries (supplied) by matching the + and - on the batteries to the + and - inside the battery compartment. With normal use, the batteries should last for approximately six months. Model shown is RM-Y116. RM-Y117 uses one battery.

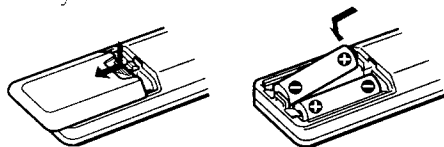

### Notes

- Remove the batteries to avoid possible damage from battery leakage if you will not be using the remote control for an extended period of time.
- Handle the remote control with care. Avoid dropping it, getting it wet, or placing it in direct sunlight, near a heater, or where the humidity is high.

## Changing the Menu Language

### Except Canadian models

If you want to view the menus in Spanish, you can change the menu language.

#### 1 Press MENU.

The Main menu appears.



#### 2 Press $\Delta+$ or $\nabla-$ to move the cursor ( $\blacktriangleright$ ) to ENGLISH and press RETURN.

ENGLISH will turn red.

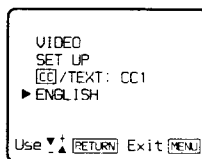
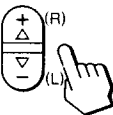

#### 3 Press $\Delta+$ or $\nabla-$ to select ESPAÑOL and press RETURN.

ESPAÑOL will turn green.

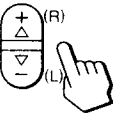

#### 4 Press MENU to return to the TV program.

### Note

- Some parts of the Spanish menus will appear in English.

## Step 3: Setting up Your Channels

### Setting Cable TV On or Off

If you have connected the TV to a cable TV system, set CABLE to ON. If not, set CABLE to OFF.

- 1 Press **MENU**.
- 2 Move the cursor to **SET UP** and press **RETURN**.
- 3 Move the cursor to **CABLE** and press **RETURN**.

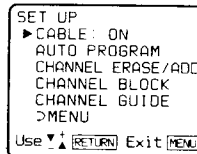

- 4 Press **Δ+** or **▽-** to select **ON** or **OFF**.
- 5 Press **RETURN**.
- 6 Press **MENU** to return to the TV program.

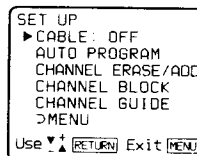

#### Note

- If the screen is black, the TV is set to a video input and you cannot select CABLE. Press **TV/VIDEO** until a channel number appears, then follow steps 1–6.

### Auto Programming Your Channels

TV channels can be preset easily. First, you can store all the receivable channels automatically. Later, you can erase unwanted channels or add additional channels.

#### Notes

- If the TV is set to **VIDEO**, you cannot run **AUTO PROGRAM**. Press **TV/VIDEO** on the remote control until a channel number appears.
- It is usually best to preset channels during the day when the greater number of channels are broadcasting.

- 1 Press **MENU**.

The Main menu appears.

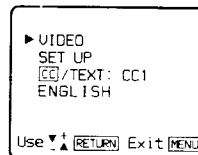

- 2 Press **Δ+** or **▽-** on the remote control to move the cursor (▶) to **SET UP**. Press **RETURN**.

The **SET UP** menu appears.

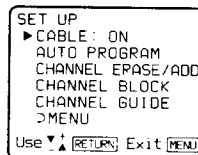
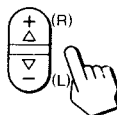

- 3 Press **Δ+** or **▽-** to move the cursor to **AUTO PROGRAM** and press **RETURN**.

**AUTO PROGRAM** appears on the screen and the TV starts scanning and presetting channels.

When all of the receivable channels are stored, **AUTO PROGRAM** disappears.

#### Note

- **AUTO PROGRAM** will tune in all of the channels in your area, including some with weak or scrambled signals. They will appear fuzzy on the screen. You can erase them using **CHANNEL ERASE/ADD**.
- Pressing any button on the remote control while **AUTO PROGRAM** is scanning and presetting channels will cause **AUTO PROGRAM** to stop.

## Erasing or Adding Channels

After you run AUTO PROGRAM, you can erase unnecessary channels or add new ones.

- 1 Press **MENU**.
- 2 Press  $\Delta+$  or  $\nabla-$  to select **SET UP** and press **RETURN**.
- 3 Press  $\Delta+$  or  $\nabla-$  to select **CHANNEL ERASE/ADD** and press **RETURN**.

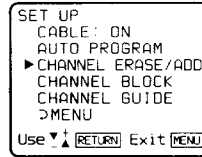
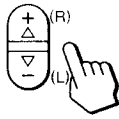

4 **To erase or add a channel:**

- (1) Press **CH +/-** or **0-9** to select the channel you want to erase or add.
- (2) Press  $\Delta+$  or  $\nabla-$  to select **ERASE** or **ADD**.
- (3) Press **RETURN**.

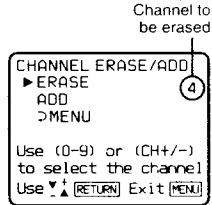

If you are erasing a channel, the “-” symbol appears next to the channel number. If you are adding a channel, the “+” symbol appears next to the channel number.

5 **To erase or add other channels, repeat step 4.**

6 **Press MENU to return to the TV program.**

**Note**

- If you erase or add a VHF or UHF channel, the cable TV channel with the same number is also erased or added.

# Watching the TV

Press **POWER** to turn the TV on.

**Note**

- If **VIDEO** appears on the screen, press **TV/VIDEO** so that a channel number appears.

## Selecting a Channel Directly

Press **0-9** to select a channel.

The channel will change after 2 seconds, or you can press **ENTER** for immediate selection.

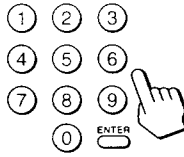

## Scanning Through Channels

Press **CH +/-** until the channel you want appears.

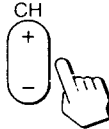

## Jumping Quickly Between Two Channels

Press **JUMP**.

The TV switches from the current channel to the previous channel that you watched.

Pressing **JUMP** again switches back to the first channel.



**Note**

- You can only jump to channels you have selected with the 0-9 keys, or back to the last channel you scanned.

## Adjusting the Volume

Press **VOL +/-** to adjust the volume.

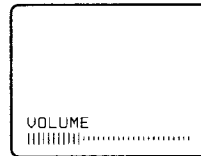
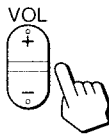

## Muting the Sound

Press **MUTING**.

**MUTING** appears on the screen.

To restore the sound, press **MUTING** again, or press **VOL +**.





## Displaying On-Screen Information

Use the DISPLAY key to check the TV's Display settings.

**1 Press DISPLAY.**

The channel number will be displayed. The TV will also display the MTS mode if SAP, MAIN, or MONO are selected (KV-20S20, 20S21, 20S30, 20V60, 21RS20, 21RS20C, 21RS30C, 21SD1 only). The MTS mode display disappears after 4 seconds.

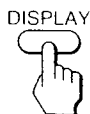

**2 Press DISPLAY again.**

XDS ON will appear on the screen. If XDS (Extended Data Service) is broadcasting, information will then appear on the screen (except KV-13M20, 14PM1, 14R20, 14R20C, 14RD1)

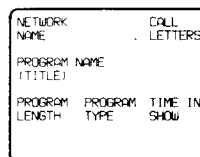

**3 Press DISPLAY again.**

CC1 ON (if selected) will appear on the screen for a few seconds. Captions will then appear at the top or bottom of the screen.

**4 To turn off Caption Vision or XDS display, press DISPLAY again until DISPLAY OFF appears.**

**Note**

- See page 13 for more information about Caption Vision.

## Watching Video Tapes

**1 Press TV/VIDEO until the correct video input appears.**



**2 Press PLAY on your VCR to view the video tape.**

**3 Press TV/VIDEO to return to the TV program.**

## Setting the Sleep Timer

The sleep timer allows the TV to stay on for a length of time and then shut off automatically.

**1 Press SLEEP until the time you want appears.**

Each time you press SLEEP, the display moves between 30, 60, 90, and OFF.

SLEEP appears one minute before the TV shuts off.

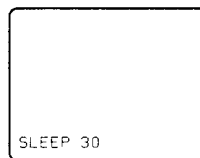

**2 To cancel the sleep timer, press SLEEP again until SLEEP OFF appears, or turn off the TV.**

# Using the VIDEO Menu

## Adjusting the Video Settings

You can adjust the picture, hue, color, brightness, and sharpness of any TV image.

- 1 Press **MENU**.
- 2 Move the cursor (▶) to **VIDEO** and press **RETURN**.



- 3 Press **Δ+** or **∇-** to select the feature that you want to adjust and press **RETURN**.

See the Adjustable Items chart for a list of the adjustments you can make.

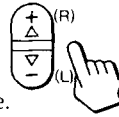

- 4 Press **Δ+** or **∇-** to adjust the setting of the selected feature and press **RETURN**.

The new setting appears in the VIDEO menu.

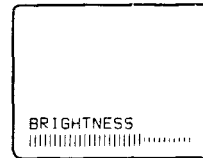
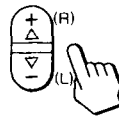

- 5 To adjust other video settings, repeat steps 3 and 4.
- 6 Press **MENU** to return to the TV program.

### ADJUSTABLE ITEMS

Item	Press Δ+ (R) to	Press ∇- (L) to
PICTURE	Increase the contrast	Decrease the contrast
HUE	Increase the green tones	Decrease the green tones
COLOR	Increase color intensity	Decrease color intensity
BRIGHTNESS	Brighten the picture	Darken the picture
SHARPNESS	Sharpen the picture	Soften the picture

### Restoring the factory video settings

- 1 To restore the factory video settings, press **RESET** while the **VIDEO** menu is displayed.  
All the settings except **PICTURE** are restored to factory settings.

## Additional Features

### Selecting Stereo or Bilingual Programs (MTS)

*KV-20520, 20521, 20530, 20V60, 21P51, 21R520, 21R520C, 21R530C, 21SD1 only. Menus shown are for KV-20520.*

The Multichannel TV Sound (MTS) feature allows you to enjoy stereo sound (MAIN), Second Audio Programs (SAP), or monaural sound (MONO) when available.

- 1 Press **MENU**.
- 2 Move the cursor to **AUDIO** and press **RETURN**.
- 3 Move the cursor to **MTS** and press **RETURN**.
- 4 Press  $\Delta$ + or  $\nabla$ - to select **MAIN**, **SAP**, or **MONO**.
- 5 Press **MENU** to return to the TV program.

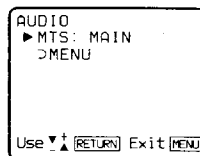
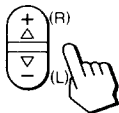

Choose	To
MAIN	Listen to stereo sound.
SAP	Listen to bilingual and other programs.
MONO	Reduce noise during poor stereo broadcasts.

#### Note

- The sound of non-SAP programs may be muted when SAP is selected.

### Setting the Speaker Switch (SPEAKER)

*KV-20530, 20V60, 21R530C only.*

You can listen to the TV sound through your TV and a separate stereo system, or switch off the TV speakers to listen to TV sound only through the stereo.

- 1 Press **MENU**.
- 2 Move the cursor to **AUDIO** and press **RETURN**.
- 3 Move the cursor to **SPEAKER** and press **RETURN**.  
If you select **OFF**, **VARIABLE** and **FIXED** will appear. See step 5 of "Changing Audio Out Speaker Volume".
- 4 Press  $\Delta$ + or  $\nabla$ - to select **ON** or **OFF**.
- 5 Press **MENU** to return to the TV program.



Choose	To
ON	Listen to the sound from the TV, or through the TV and a separate stereo system.
OFF	Turn off the TV speaker and listen to the TV's sound through external audio system speakers only.

### Changing Audio Out Speaker Volume

*KV-20530, 20V60, 21R530C only.*

You can control the volume of the TV program when you play the TV sound through a separate stereo system.

- 1 Press **MENU**.
- 2 Move the cursor to **AUDIO** and press **RETURN**.
- 3 Move the cursor to **SPEAKER** and press **RETURN**.
- 4 Press  $\Delta$ + or  $\nabla$ - to set **SPEAKER** to **OFF** and press **RETURN**.



- 4 Move the cursor to 1 or 2 and press RETURN.

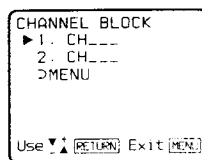

- 5 Press  $\Delta+$  or  $\nabla-$  to select the channel that you want to block. Press RETURN.

- 6 Repeat steps 4 and 5 to enter the second channel that you want to block.



- 7 Press MENU to return to the TV program.

If you switch to the blocked channel, BLOCKED appears. The screen is black and the sound is muted.

#### To cancel a CHANNEL BLOCK setting

- 1 Follow steps 1–4 above.
- 2 Press RESET.

### Selecting a Caption Vision Option

Caption Vision options include CC1, 2, 3, and 4, or TEXT1, 2, 3, and 4. CC1, 2, 3, and 4 show a caption or printed version of the dialog or sound effects of a program. CC1 will be the setting for most programs. TEXT1, 2, 3, and 4 show text information on half of the screen. This text is not usually related to the program.

- 1 Press MENU.
- 2 Press  $\Delta+$  or  $\nabla-$  to select [CC/TEXT: CC1] and press RETURN.

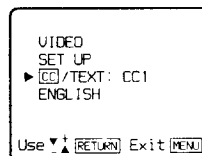
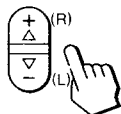

- 3 Press  $\Delta+$  or  $\nabla-$  to select the caption type (CC1, 2, 3, 4, or TEXT1, 2, 3, or 4) and press RETURN.
- 4 Press MENU to return to the TV program.
- 5 To view Caption Vision, press DISPLAY several times until CC1, 2, 3, 4, or TEXT1, 2, 3, 4 ON is displayed, if broadcasting. The caption will appear in a few seconds.
- 6 To turn off Caption Vision, press DISPLAY until DISPLAY OFF appears.

#### Notes

- Captions disappear for a few seconds when you press the MUTING button.
- Captions may appear with a white box or other errors if you have poor reception of the channel.

### Customizing the Channel Number Buttons (CHANNEL GUIDE)

You can assign up to 12 of your favorite channels to CHANNEL GUIDE locations and switch to them with the CHANNEL GUIDE.

- 1 Press MENU.
- 2 Press  $\Delta+$  or  $\nabla-$  to select SET UP and press RETURN.
- 3 Press  $\Delta+$  or  $\nabla-$  to select CHANNEL GUIDE and press RETURN.

- 4 Press RETURN again to move the cursor to the number pad.

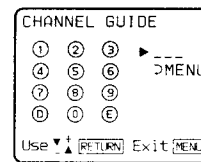

- 5 Press  $\Delta$ + or  $\nabla$ - to select a number on the CHANNEL GUIDE (the button number will turn red) and press RETURN.

The \_\_\_ turns red.

Buttons 0-9, DISPLAY (D) and ENTER (E) are available for CHANNEL GUIDE access.

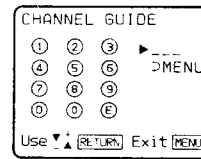

- 6 Press  $\Delta$ + or  $\nabla$ - to select the channel that you want to assign to that button, and press RETURN.

The TV will switch to that channel.

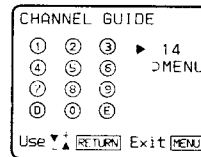

- 7 Repeat steps 5-7 to set other channels.

- 8 Press MENU to return to the current TV program.

To remove a CHANNEL GUIDE setting

- 1 Repeat steps 1-6 to select the channel that you want to remove.
- 2 Press RESET.

## Using the CHANNEL GUIDE

- 1 Press CH GUIDE.

The CHANNEL GUIDE shows button numbers and the channels assigned to them.

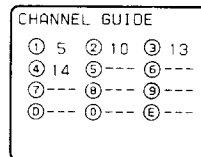

- 2 Press 0-9, DISPLAY or ENTER on the remote control to switch to the channel you want to view.
- 3 To cancel the CHANNEL GUIDE display without selecting a channel, press CH GUIDE again.

## Listening with Headphones or an Earphone

Plug the headphones or earphone into the jack on the front of the TV. Using headphones will turn off the sound to the TV speakers.

### Notes

- To prevent hearing damage due to sudden or prolonged excessive volume, do not set the volume too high while listening.
- If your TV is monaural, the monaural sound will be heard from both headphones.

# Troubleshooting

If you are having a problem with your TV, try the suggestions below. If the problem persists, contact your nearest Sony dealer.

<b>Problem</b>	<b>Suggestion</b>
<b>No picture, no sound</b>	<ul style="list-style-type: none"><li>• Make sure the power cord is connected.</li><li>• Check the TV/VIDEO setting: when watching TV, set to TV; when watching video tapes, set to VIDEO (page 9).</li><li>• Try another channel. It could be station trouble.</li></ul>
<b>Poor or no picture, good sound</b>	<ul style="list-style-type: none"><li>• Adjust PICTURE in the VIDEO menu (page 10).</li><li>• Adjust BRIGHTNESS in the VIDEO menu (page 10).</li><li>• Check the antenna and/or cable connections (page 3).</li></ul>
<b>Good picture, no sound</b>	<ul style="list-style-type: none"><li>• Press MUTING so that MUTING disappears from the screen (page 8).</li><li>• Check that MTS is set to MAIN or MONO (page 11).</li><li>• Make sure SPEAKER is set to ON in the AUDIO menu (page 11). (KV-20S30, 20V60, 21RS30C only).</li></ul>
<b>No color</b>	<ul style="list-style-type: none"><li>• Adjust COLOR in the VIDEO menu (page 10).</li><li>• Make sure that a black and white program is not being broadcast.</li></ul>
<b>Only snow appears on the screen</b>	<ul style="list-style-type: none"><li>• Check the CABLE setting in the SET UP menu (page 6).</li><li>• Check the antenna and/or cable connections (page 3).</li><li>• Make sure the channel is currently broadcasting.</li></ul>
<b>Dotted lines or stripes</b>	<ul style="list-style-type: none"><li>• Adjust the antenna.</li><li>• Move the TV away from sources of electrical noise such as computers, microwaves, and hair-dryers.</li></ul>
<b>Double images or ghosts</b>	<ul style="list-style-type: none"><li>• Use a highly directional outdoor antenna or a cable. This problem is often caused by reflections from nearby mountains or tall buildings.</li></ul>
<b>Cannot receive higher number channels (UHF) when using an antenna</b>	<ul style="list-style-type: none"><li>• Make sure CABLE is OFF in the SET UP menu (page 6).</li><li>• Use AUTO PROGRAM to add channels that are not presently in the memory (page 6).</li></ul>
<b>Cable stations don't seem to work</b>	<ul style="list-style-type: none"><li>• Make sure CABLE is ON in the SET UP menu (page 6).</li><li>• Use AUTO PROGRAM to add channels that are not presently in the memory (page 6).</li></ul>
<b>Remote control does not operate</b>	<ul style="list-style-type: none"><li>• Batteries could be weak. Replace them (page 5).</li><li>• Make sure the TV's power cord is securely connected to a wall outlet.</li><li>• Move the TV 3-4 feet away from fluorescent lights.</li></ul>
<b>The TV needs to be cleaned</b>	<ul style="list-style-type: none"><li>• Clean the TV with a soft dry cloth. Never use strong solvents such as thinner or benzine, which might damage the finish of the cabinet.</li></ul>

# Specifications

## **For all models (except as noted)**

Television system	American TV standard
Channel coverage	VHF: 2-13/UHF: 14-69/CATV: 1-125
Antenna	75-ohm external antenna terminal for VHF/UHF
Picture tube	Trinitron tube
Power requirements	120 V, 60 Hz 220 V, 50/60 Hz (KV-14R20C, 21R20C, 21RS20C, 21RS30C only)
Supplied accessories	Size AA (R6) batteries (2) Antenna connector (except KV-20M20, 20S20, 20S21, 20S30, 20V60) Remote control RM-Y116 (1) Remote control RM-Y117 (1) (KV-20V60 only) Antenna dipole (except KV-20M20, 20S20, 20S21, 20S30, 20V60)
Optional accessory	Antenna dipole (KV-20M20, 20S20, 20S21, 20S30, 20V60)

## **KV-13M20, 13M30, 13M31, 14PM1, 14R20, 14R20C, 14RD1**

Screen size	13 in., 14 in.
Inputs	1 video, 1 audio (KV-13M20, 14PM1, 14R20, 14R20C, 14RD1 only) 2 video, 2 audio (KV-13M30, 13M31 only)
Speaker output	2 W
Power consumption	75 W when in use 6 W in standby 8 W in standby (KV-14R20C only)
Dimensions (W/H/D)	358 x 342 x 401 mm (14 1/2 x 13 1/2 x 15 3/4 in.)
Mass	10 kg (22 lbs)

## **KV-20M20, 21PM1, 21R20, 21R20C, 21RD1**

Screen size	20 in., 21 in.
Inputs	1 video, 1 audio
Speaker output	2 W
Power consumption	90 W when in use 6 W in standby 8 W in standby (KV-21R20C only)
Dimensions (W/H/D)	522 x 477 x 471.7 mm (20 1/2 x 18 3/4 x 18 1/2 in.)
Mass	21.3 kg (46 lbs, 13 oz)

## **KV-20S20, 20S21, 20S30, 20V60, 21PS1, 21RS20, 21RS20C, 21RS30C, 21SD1**

Screen size	20 in., 21 in.
Inputs/outputs	1 video, 1 audio (KV-20S20, 20S21, 21PS1, 21RS20, 21RS20C, 21SD1 only) 2 video, 2 audio (KV-20S30, 21RS30C only) S-Video (KV-20V60 only) Variable Audio Out (KV-20S30, 20V60, 21RS30C only)
Speaker output	2 W + 2 W
Power consumption	90 W when in use 7 W in standby 8 W in standby (KV-21RS20C, 21RS30C only)
Dimensions (W/H/D)	522 x 477 x 471.7 mm (except KV-20V60) (20 1/2 x 18 3/4 x 18 1/2 in.) (except KV-20V60) 550 x 464 x 468.8 mm (KV-20V60 only) (21 1/2 x 18 1/4 x 18 1/2 in.) (KV-20V60 only)
Mass	21.4 kg (47 lbs) (except KV-20V60) 23.4 kg (51 lbs, 8 oz) (KV-20V60 only)

Design and specifications are subject to change without notice.

Sony Corporation Printed in U.S.A.



**Using the Pre-Programmed Remote Commander**

With the supplied Remote Commander, you can operate a Sony video cassette recorder (Beta, 8 mm, VHS) or a video disc player as well as most non-Sony video equipment connected to your TV by following the steps below.

- 1 While pressing CODE SET, press 0 – 9 to enter the manufacturer's code number. For example, to operate a Sony 8 mm VCR, press 0, 2 and ENTER.**

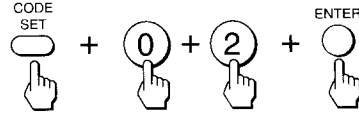

- 2 Use the video operating buttons on the Remote Commander to operate the video equipment.**

**Operating a VCR**

- To turn on or off Press (VIDEO) POWER.
- To change channels (when watching TV programs through the VCR's tuner) Press CH +/-.
- To record Press ● (2 buttons simultaneously).
- To play Press ►.
- To stop Press ■.
- To fast forward Press ►►.
- To rewind the tape Press ◄◄.
- To pause Press II.
- To search the picture forward and backward Press ►► or ◄◄ during playback.

**Operating a Video Disc Player**

- To play Press ►.
- To stop Press ■.
- To pause Press II.
- To resume normal playback, press again.
- This function is effective only for a CAV (standard-play disc). With CLV (extended-play disc), the TV will go into the standby mode if II is pressed.
- To search the picture forward and backward Keep pressing ►► or ◄◄ during playback.
- To resume normal playback, release the button.

**Manufacturer's Code Numbers (VCR/ video disc player)**

Manufacturer	Code number
SONY	01, 02, 03, 04
CANON	05
EMERSON	22, 30, 33
FISHER	10, 11, 12, 15
FUNAI	29
GENERAL ELECTRIC	05, 08
GOLDSTAR	25
HITACHI	07, 08, 36
JVC	16, 35
MAGNAVOX	05, 06, 09
MITSUBISHI	18, 19, 26, 27
MULTITECH	29
NEC	16, 23, 31
PANASONIC	05, 06
PHILCO	05, 06
PHILIPS	05, 06, 09
QUASAR	05, 06
RCA	07, 08
SAMSUNG	24, 32
SANYO	11, 15
SCOTT	21
SHARP	13, 14
SHINTOM	34
SYLVANIA	05, 06, 09
SYMPHONIC	29
TEKNIKA	28, 29
TOSHIBA	20, 21
TOTE VISION	25
ZENITH	17

The code numbers for Sony equipment are assigned as follows:

- 01.....Beta, ED Beta VCR
- 02.....8 mm VCR
- 03.....VHS VCR
- 04.....Video disc player

**Notes**

- If more than one code number is listed, try entering them one by one, until you come to the correct code for your equipment.
- In some rare cases, you may not be able to operate your non-Sony video equipment with this remote commander. This is because your equipment may use a code that is not provided with this remote commander. In this case, please use the equipment's own remote control.

**Caution**

When you remove a battery from the remote commander, the code may revert to the factory setting. Reprogram the code each time you replace the battery.

## Utilisation de la Télécommande Préprogrammée

Suivez la procédure ci-après pour commander un appareil vidéo raccordé à votre téléviseur, comme un magnétoscope (Beta, 8 mm, et VHS), un lecteur vidéodisques Sony, ou la plupart des appareils vidéo d'autres fabricants.

- 1 **Gardez la touche CODE SET enfoncée et tapez le numéro de code du fabricant de votre appareil vidéo à l'aide des touches numériques 0 - 9. Par exemple, pour piloter un magnétoscope 8 mm Sony, tapez 0, 2, puis appuyez sur ENTER.**

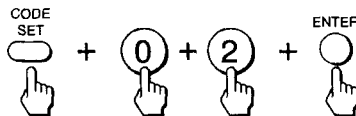

- 2 **Utilisez les touches vidéo de la télécommande pour piloter votre appareil vidéo.**

### Pilotage d'un magnétoscope

- |  |   |
|--|---|
| Pour l'allumer ou l'éteindre   | Appuyez sur (VIDEO) POWER.                      |
| Pour changer les canaux (si vous regardez des émissions TV par le tuner du magnétoscope) | Appuyez sur CH +/-.                             |
| Pour enregistrer   | Appuyez sur ● (les deux touches simultanément). |
| Pour lire une cassette   | Appuyez sur ►.                                  |
| Pour arrêter l'appareil  | Appuyez sur ■.                                  |
| Pour faire avancer rapidement une cassette   | Appuyez sur ►►.                                 |
| Pour rembobiner la bande   | Appuyez sur ◀◀.                                 |
| Pour faire une pause   | Appuyez sur   .                                 |
| Pour chercher une image vers l'avant ou vers l'arrière                                   | Appuyez sur ►► ou ◀◀ pendant la lecture.        |

### Pilotage d'un lecteur de vidéodisques

- |                          |                 |
|--------------------------|-----------------|
| Pour lire un vidéodisque | Appuyez sur ►.  |
| Pour arrêter l'appareil  | Appuyez sur ■.  |
| Pour faire une pause     | Appuyez sur   . |
- Appuyez à nouveau pour reprendre la lecture normale.
- Cette fonction n'est disponible que pour les vidéodisques de format standard (CAV). Pour les disques longue durée (CLV), le téléviseur se met en mode d'attente lorsque vous appuyez sur ||.

Pour chercher une image vers l'avant ou vers l'arrière

Gardez les touches ►► ou ◀◀ enfoncée pendant la lecture.

Relâchez la touche pour reprendre la lecture normale.

## Fabricants et Numéros de Code (Magnétoscopes)

Fabricant	Numero de code
SONY	01, 02, 03, 04
CANON	05
EMERSON	22, 30, 33
FISHER	10, 11, 12, 15
FUNAI	29
GENERAL ELECTRIC	05, 08
GOLDSTAR	25
HITACHI	07, 08, 36
JVC	16, 35
MAGNAVOX	05, 06, 09
MITSUBISHI	18, 19, 26, 27
MULTITECH	29
NEC	16, 23, 31
PANASONIC	05, 06
PHILCO	05, 06
PHILIPS	05, 06, 09
QUASAR	05, 06
RCA	07, 08
SAMSUNG	24, 32
SANYO	11, 15
SCOTT	21
SHARP	13, 14
SHINTOM	34
SYLVANIA	05, 06, 09
SYMPHONIC	29
TEKNIKA	28, 29
TOSHIBA	20, 21
TOTE VISION	25
ZENITH	17

Les numéros de code Sony correspondent aux types de matériels suivants:

- 01.....Magnétoscopes Beta, ED Beta
- 02.....Magnétoscope 8 mm
- 03.....Magnétoscope VHS
- 04.....Lecteur de vidéodisques

### Remarques

- Si plus d'un numéro de code est listé, essayez de les indiquer un par un jusqu'à ce que le code exact pour votre matériel soit localisé.
- Dans de rares cas, il est possible que la télécommande ne puisse pas être utilisée avec le matériel d'un autre fabricant. La raison est que le code n'est pas reconnu par la télécommande. Utilisez dans ce cas la télécommande propre à l'équipement.

### Attention

Chaque fois que vous changez la pile de la télécommande, le code reprend la valeur aux réglages par défaut. Reprogrammez le code après chaque remplacement de la pile.